

**EN** **ATV TRAILER INSTALLATION MANUAL**

**DE** **MONTAGEANLEITUNG ZU UNIVERSALANHÄNGER**

**RU** **ИНСТРУКЦИЯ ПО СБОРКЕ УНИВЕРСАЛЬНОГО ПРИЦЕПА**

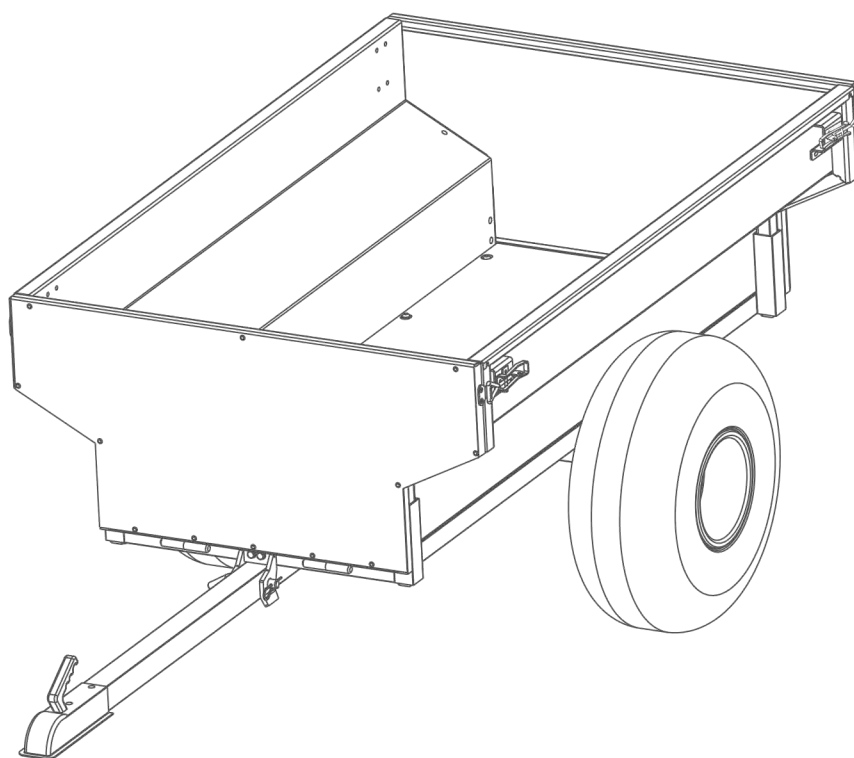

**ATV TRAILER 1500 + FITTING KIT**

2444.0091.1

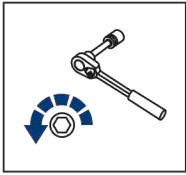

EN Regular fasteners  
DE Schraube herausdrehen  
RU Штатный крепеж

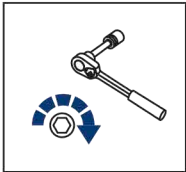

EN Regular fasteners  
DE Schraube eindrehen und festziehen  
RU Штатный крепеж

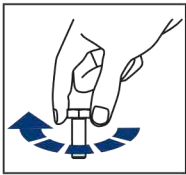

EN Screw a several turns  
DE Schraube wenige Umdrehungen eindrehen  
RU Вкрутить на несколько оборотов



EN Loosen bolts  
DE Schraube wenige Umdrehungen lösen  
RU Выкрутить на несколько оборотов

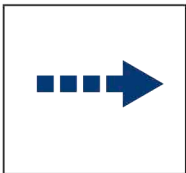

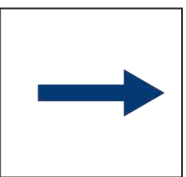

EN Movement Arrow  
DE Bewegungsrichtung  
RU Движение











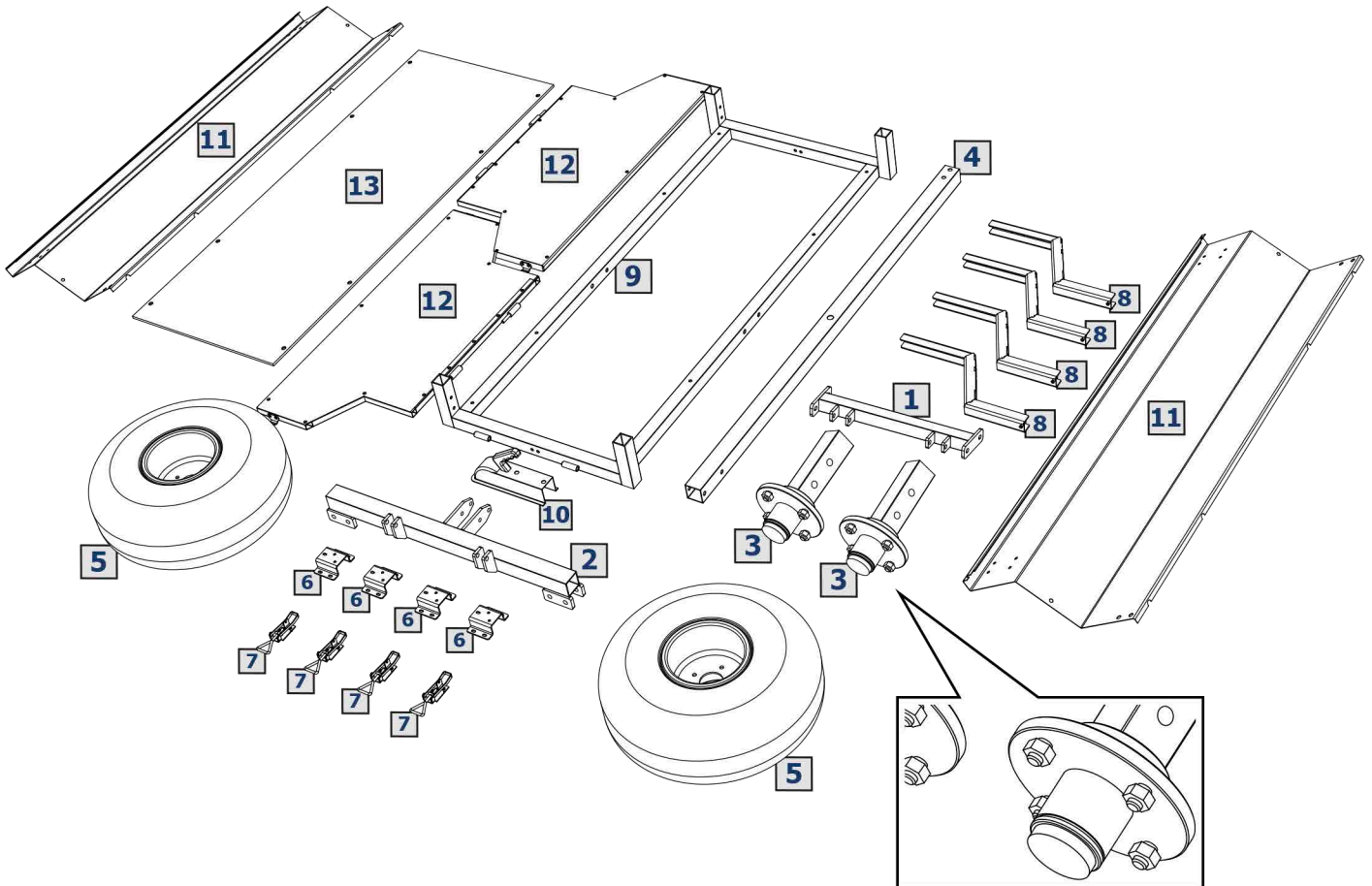

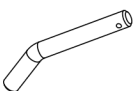



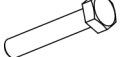
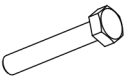
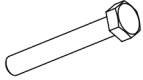

EN Location/Position Arrow  
DE Blickrichtung / Postionsrichtung  
RU Расположение



EN Screw Arrow  
DE Drehrichtung  
RU Поворот

|   |   |   |                              |   |                        |
|---|---|---|------------------------------|---|------------------------|
|  | EN Ratchet<br>DE Ratsche<br>RU Трещётка |  | S - 10;<br>S - 13;<br>S - 17 |  | HEX<br>S - 4;<br>S - 5 |
|---|---|---|------------------------------|---|------------------------|



|  |   |   |   |  |   |
|--|---|---|---|--|---|
| <b>14</b><br><br>x1                   | <b>15</b><br><br>x1        | <b>16</b><br><br>M6x16 x28 | <b>17</b><br><br>M8x20 x16 | <b>18</b><br><br>M8x60 x10  | <b>19</b><br><br>M10x70 x6           |
| <b>20</b><br><br>M10x80 x6            | <b>21</b><br><br>M10x90 x2 | <b>22</b><br><br>ø6 x28    | <b>23</b><br><br>ø8 x20    | <b>24</b><br><br>ø10 x28    | <b>25</b><br><br>M6 x28              |
| <b>26</b><br><br>M8 x10               | <b>27</b><br><br>M10 x14   | <b>28</b><br><br>x1        | <b>29</b><br><br>x4        | <b>30</b><br><br>127x978 x2 | <b>31</b><br><br>127x1422 x1<br>left |
| <b>32</b><br><br>127x1422 x1<br>right |   |   |   |  |   |

