

EN **ATV TRAILER INSTALLATION MANUAL**

DE **MONTAGEANLEITUNG ZU UNIVERSALANHÄNGER**

RU **ИНСТРУКЦИЯ ПО СБОРКЕ УНИВЕРСАЛЬНОГО ПРИЦЕПА**

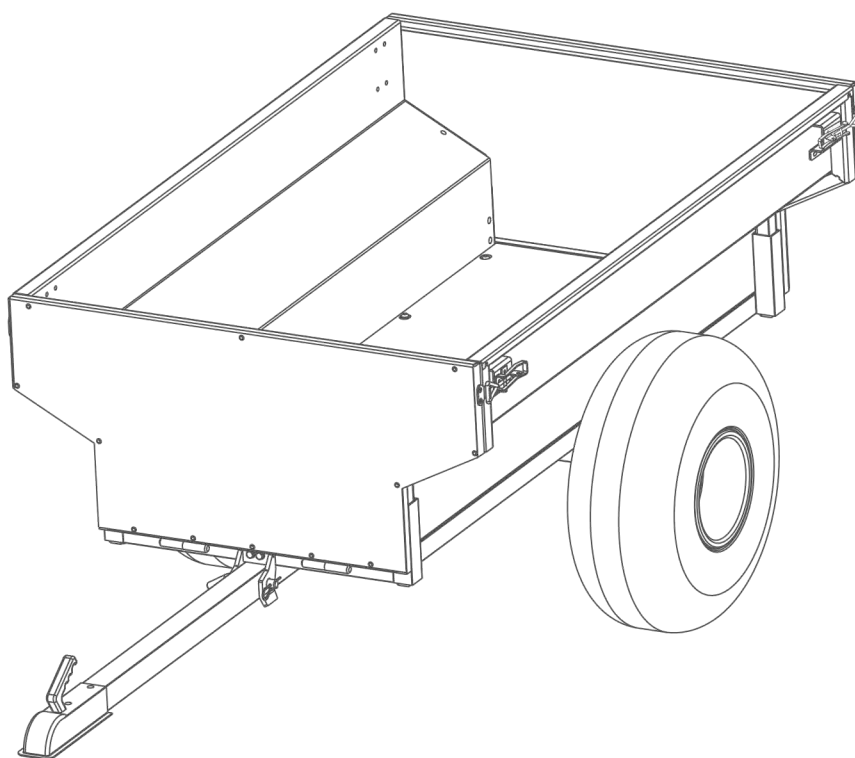

ATV TRAILER 1500 + FITTING KIT

2444.0091.1

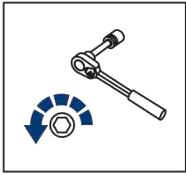

EN Regular fasteners
DE Schraube herausdrehen
RU Штатный крепеж

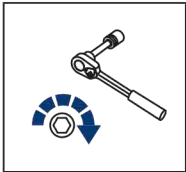

EN Regular fasteners
DE Schraube eindrehen und festziehen
RU Штатный крепеж

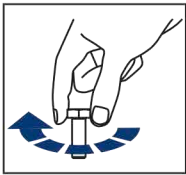

EN Screw a several turns
DE Schraube wenige Umdrehungen eindrehen
RU Вкрутить на несколько оборотов



EN Loosen bolts
DE Schraube wenige Umdrehungen lösen
RU Выкрутить на несколько оборотов

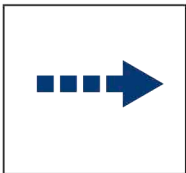

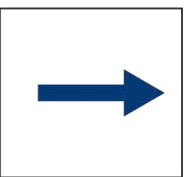

EN Movement Arrow
DE Bewegungsrichtung
RU Движение











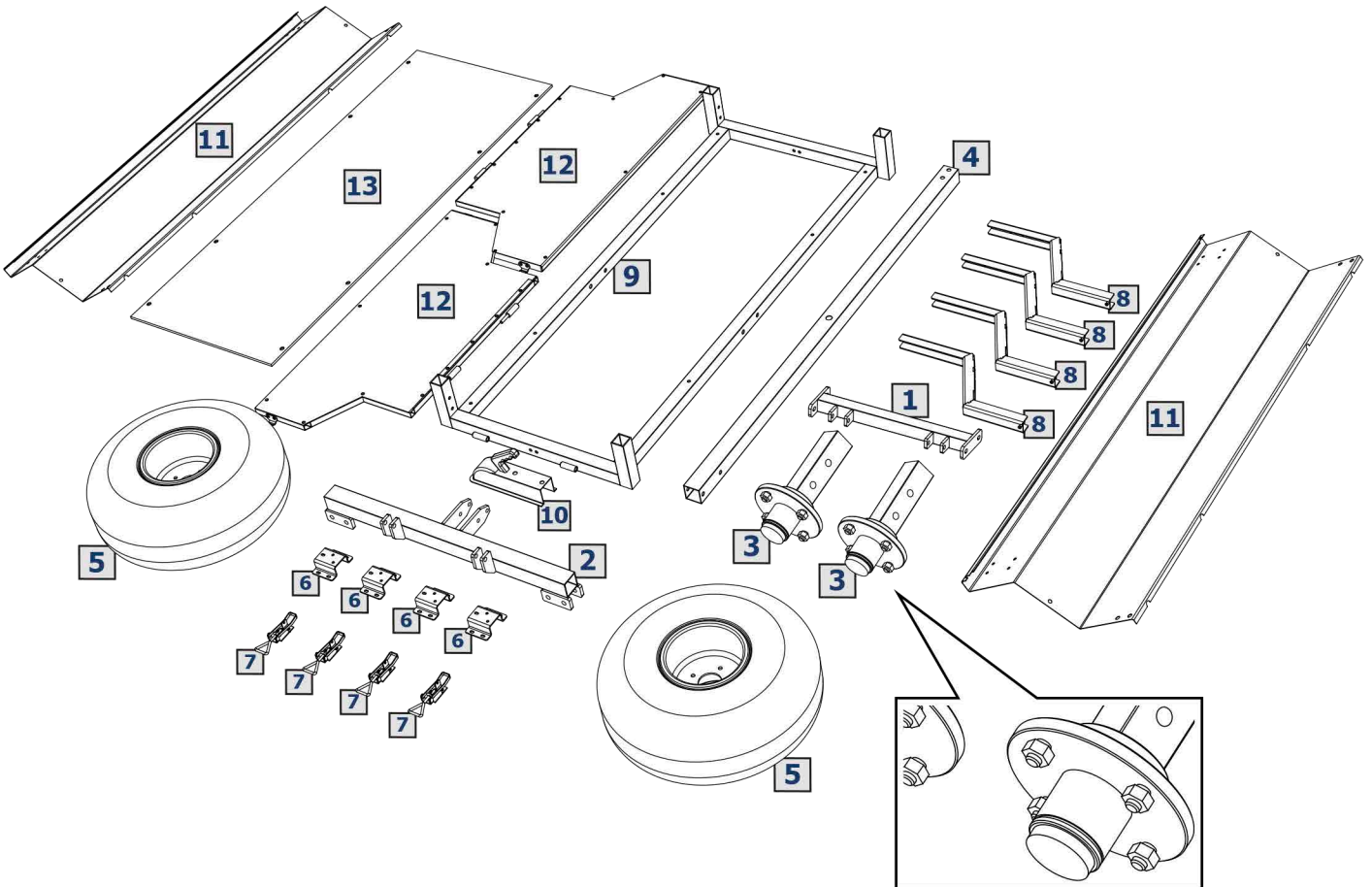

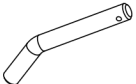

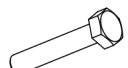
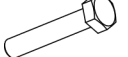
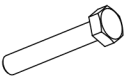
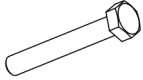

EN Location/Position Arrow
DE Blickrichtung / Postionsrichtung
RU Расположение

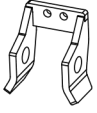

EN Screw Arrow
DE Drehrichtung
RU Поворот

	EN Ratchet DE Ratsche RU Трещётка		S - 10; S - 13; S - 17		HEX S - 4; S - 5
---	---	---	------------------------------	---	------------------------



14  x1	15  x1	16  M6x16 x28	17  M8x20 x16	18  M8x60 x10	19  M10x70 x6
20  M10x80 x6	21  M10x90 x2	22  ø6 x28	23  ø8 x20	24  ø10 x28	25  M6 x28
26  M8 x10	27  M10 x14	28  x1	29  x4	30  127x978 x2	31  127x1422 x1
32  127x1422 x1	right				

