

EN DOOR KIT INSTALLATION MANUAL

DE MONTAGEEINLEITUNG TÜREN SET

RU ИНСТРУКЦИЯ ПО УСТАНОВКЕ ДВЕРЕЙ КВАДРОЦИКЛА



For: Polaris RZR 1000 (2016-)

2444.7447.1;
444.7447.1



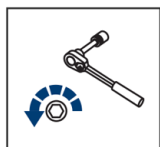

EN Regular fasteners
DE Originale montageteile
RU Штатный крепеж

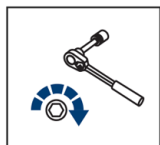

EN Regular fasteners
DE Originale montageteile
RU Штатный крепеж



EN Screw a several turns
DE Für wenigen Umdrehungen befestigen
RU Вкрутить на несколько оборотов



EN Loosen bolts
DE Bolzen lockern
RU Выкрутить на несколько оборотов

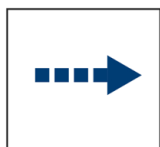

EN Movement Arrow
DE Bewegungsrichtung
RU Движение







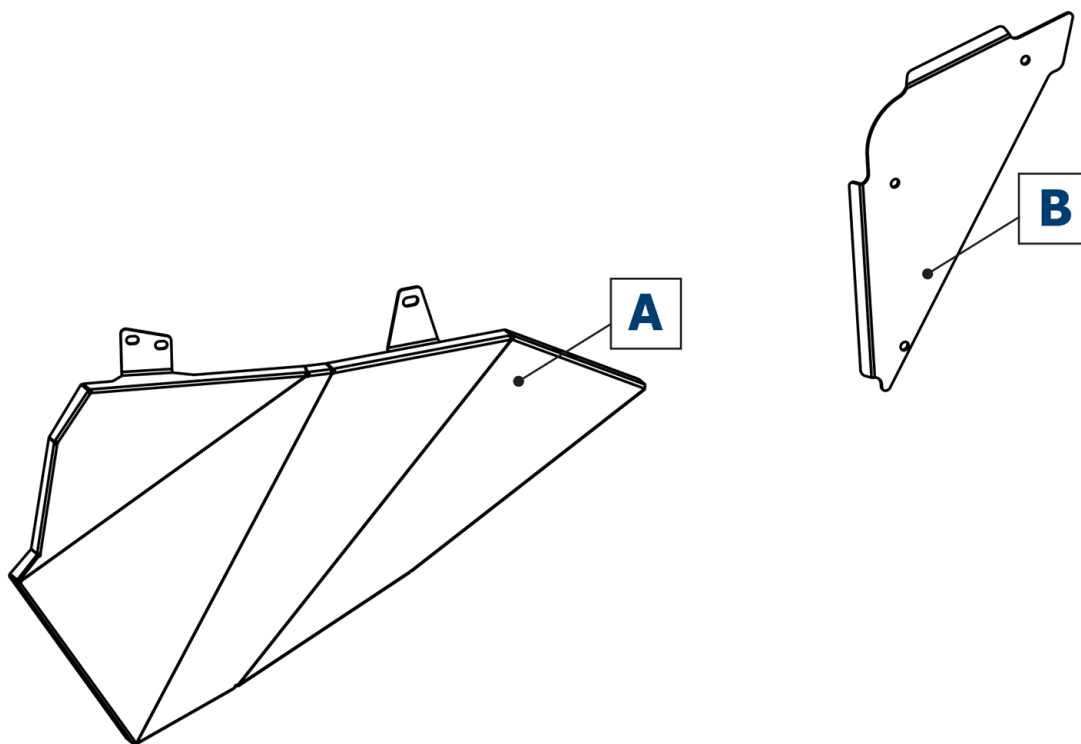
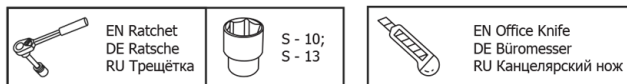

EN Location/Position Arrow
DE Anordnung/Positionsrichtung
RU Расположение

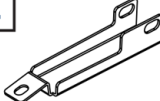

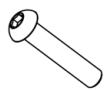
EN Screw Arrow
DE Drehungsrichtung
RU Поворот



1		2		3		4		5		6	
	x2		x6	6x40	x2	6x16	x6	Ø6	x10	M6	x8

